

# A HISTORICAL PERSPECTIVE ON ANTI-GRAVITY TECHNOLOGY

Amy Eskridge

President » The Institute for Exotic Science  
CEO » HoloChron LLC

**THE** INSTITUTE  
EXOTIC SCIENCE. EXOTIC RESULTS.

# THE INSTITUTE

EXOTIC SCIENCE. EXOTIC RESULTS.

A Public Benefit Corporation specializing in quantum computing, gravity modification, metamaterial science and communications. Huntsville-based with international co-founders and collaborators. [INSTITUTEFOREXOTICSCIENCE.COM](http://INSTITUTEFOREXOTICSCIENCE.COM)

# THE TEAM



Amy  
Eskridge  
President



Shantel  
Butler  
R&D Director



Nate  
Klose  
Creative  
Director



Sam Reid  
Gov't Affairs  
Director



Richard  
Eskridge  
Professor  
Emeritus



Paul  
Handy  
Sr. EE



# HOLCHRON

ENGINEERING

Huntsville-based father-daughter  
company with expertise in gravity  
modification research & development.



**Amy Eskridge**  
CEO, Co-founder  
Chemist,  
Entrepreneur



**Richard Eskridge**  
CTO, Co-founder  
Retired NASA  
Engineer, Scientist

# Gravity and Antigravity - Definitions

- **Gravity:** a fundamental physical force that is responsible for interactions which occur because of mass between particles, between aggregations of matter (such as stars and planets), and between particles (such as photons) and aggregations of matter, that is  $10^{-39}$  times the strength of the strong force, and that extends over infinite distances but is dominant over macroscopic distances especially between aggregations of matter
- **Antigravity:** Reducing, canceling, or protecting against the effect of gravity

# Gravity - The Basics

- Copernicus published theory of heliocentricity in 1543.
- Johannes Kepler first described the Laws of Planetary motion in early 1600's.
- Newton published the Universal Law of Gravitation in 1686.
  - $F = G \frac{m_1 m_2}{r^2}$
  - Gravity follows an inverse squared relationship with force and distance:  $F_{\text{grav}} \sim 1/d^2$ .
- First measurement of gravitational force by Henry Cavendish in 1790's.
- Einstein published general relativity in 1916.

# What does Relativity Have to Say?

- Gravity: a force or a deformation in space-time?
- Antigravity: “impossible” according to General Relativity without negative mass.
- Relativity and Newtonian Gravity agree re: negative mass generating a repulsive force.
- Standard Model of Particle Physics does not include negative mass.

# Unified Field Theory

- Four forces: gravity (graviton?), electromagnetism (photon), strong (gluon) and weak nuclear forces (W and Z bosons).
- Latter three are unified, gravity remains unexplained.
- “Graviton” postulated to be required to unify in 1934 by Soviet physicists Dmitrii Blokhintsev and F. Gal'perin
- Gravity... is it quantized???

# Anti-Gravity Research

## The Early Days

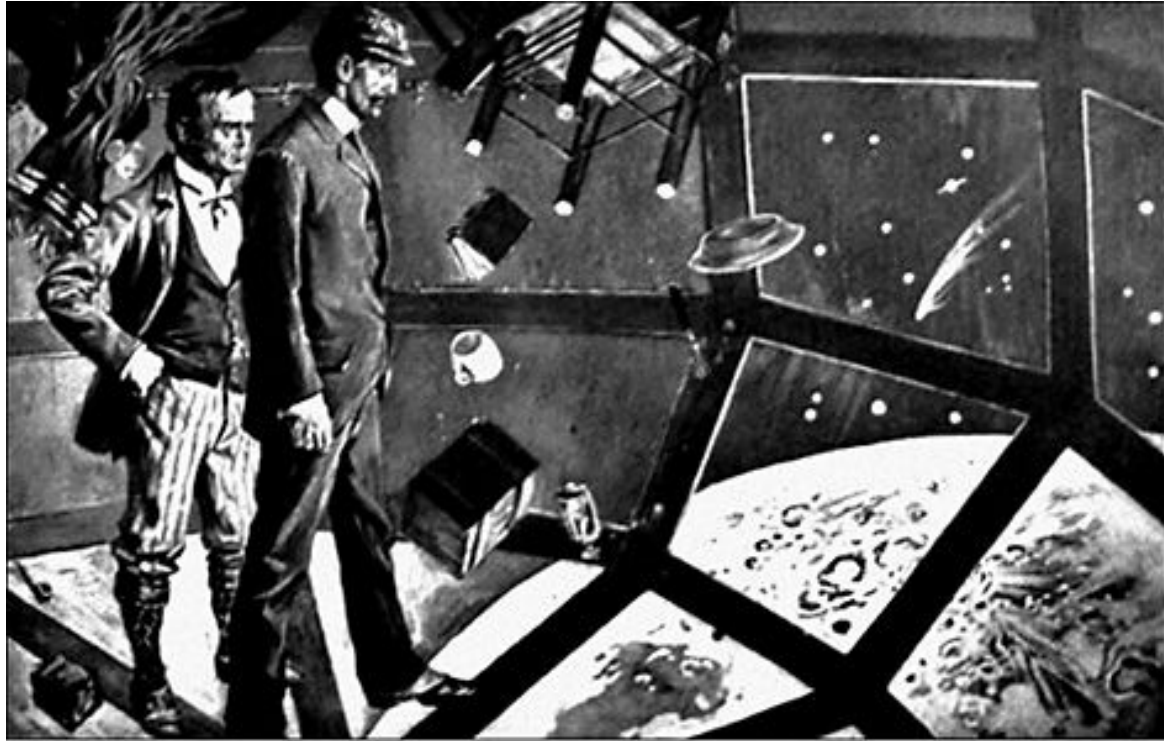

# Brown's Gravitator (1920's)

- Thomas Townsend Brown (Biefeld-Brown effect)
- Coined the term "electrogravitics"
- High voltages w/ asymmetric high dielectric fields (asymmetric capacitance)
- Vacuum tests supposedly rule out ion wind
- 1960 patent, unsubstantiated

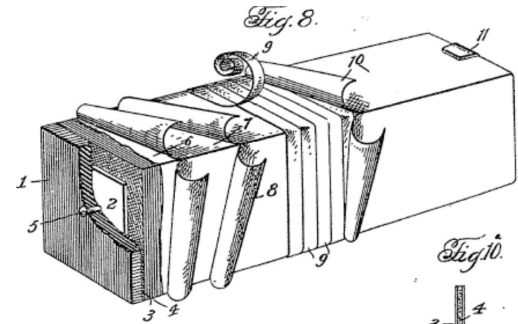
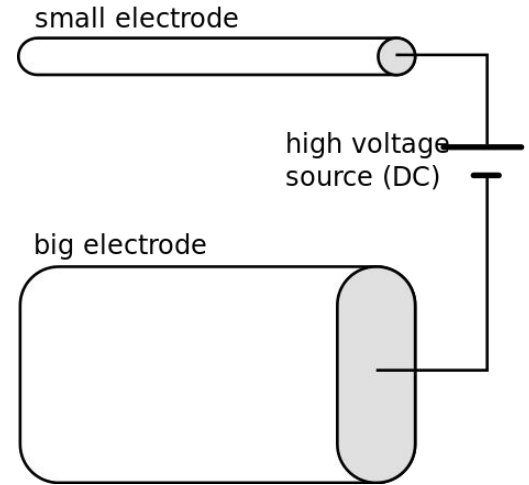

# Nikola Tesla's Space Drive (1928)

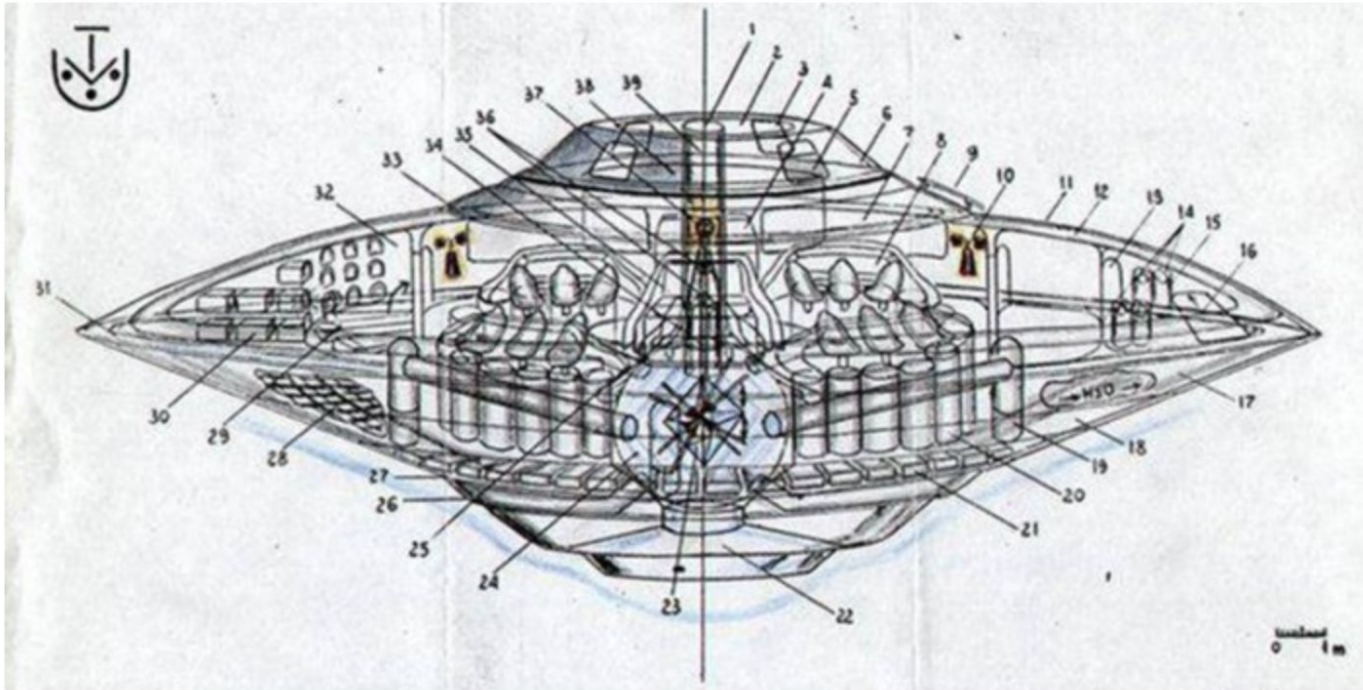

# Nikola Tesla's Space Drive (1928)

- Patent 1,655,144: a “space drive” or anti-electromagnetic propulsion system
- Electropulsation
- Dynamic Theory of Gravity - matter is made up of whirls of ether
- Rejects notion of curved space time

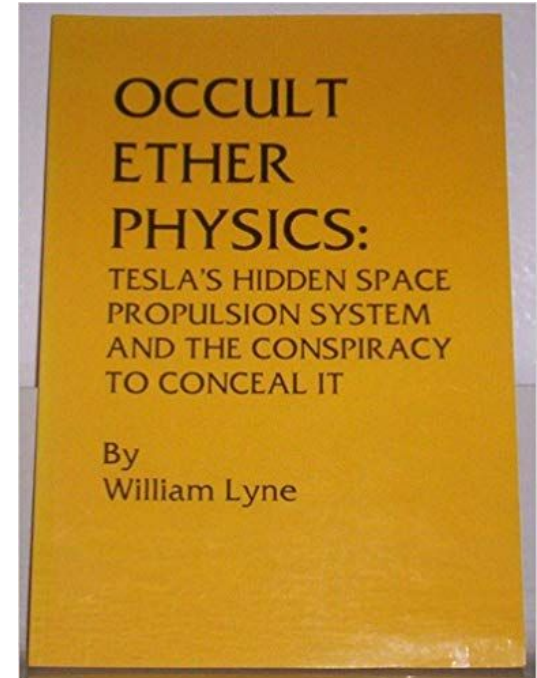

# Gravity Research Foundation

- Founded by Roger W. Babson in 1948
- Annual prize won by Stephen Hawking and 5 later Nobel Prize winners

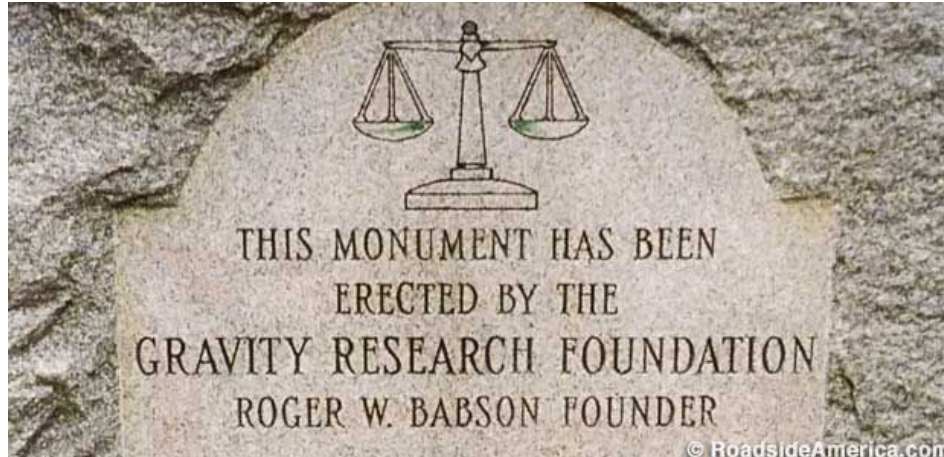

# Critical Commentary

“Before anyone can have the audacity to formulate even the most rudimentary plan of attack on the problem of harnessing the force of gravitation, he must understand the nature of his adversary. I take it as most axiomatic that the phenomenon of gravitation is poorly understood even by the best of minds, and the last word on it is very far indeed from having been spoken.”

- Bryce DeWitt (Gravity Research Foundation Essay) 1953

# Government and Contractor Programs

- Aeronautical Research Laboratory supposedly conducted research at Wright Patterson Air Force Base (1956)
- Research Institute for Advanced Study conducted research that became Lockheed Skunkworks in later years

# Searl Generator (1946)

- Claimed combination of antigravity and free energy device.
- Widely panned, still in development

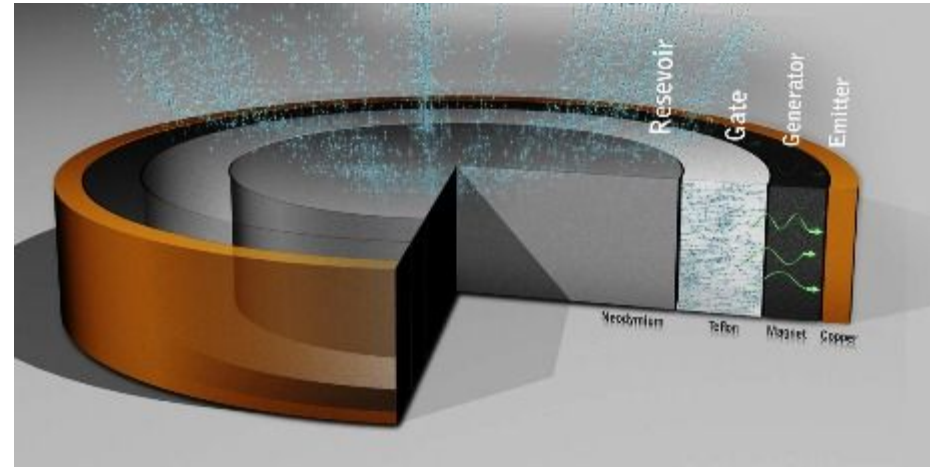

# Dean Drive (1950's-60's)

- “Reactionless drive” claimed to produce propulsion without propellant exhaust
- Linear oscillating mechanism
- Effect may be due to friction and would not work in free space

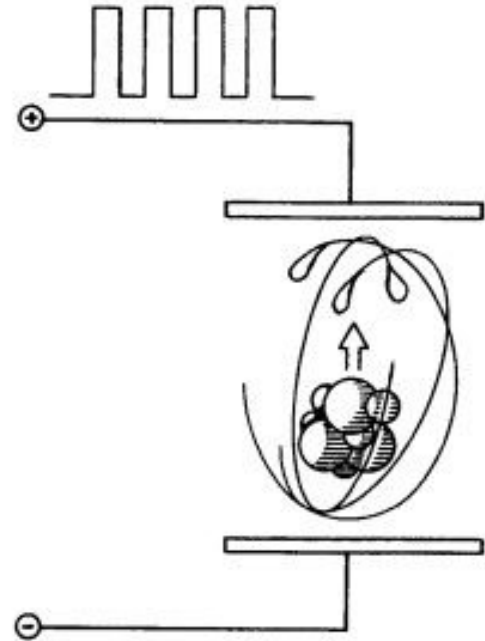

# The Wallace Machine (1968)

- Spinning brass discs ( $\frac{1}{2}$  integer nuclear spin)
- “Aligns nuclear spin”
- Patents cite “kinemassic field” as mechanism of action
- Unsubstantiated

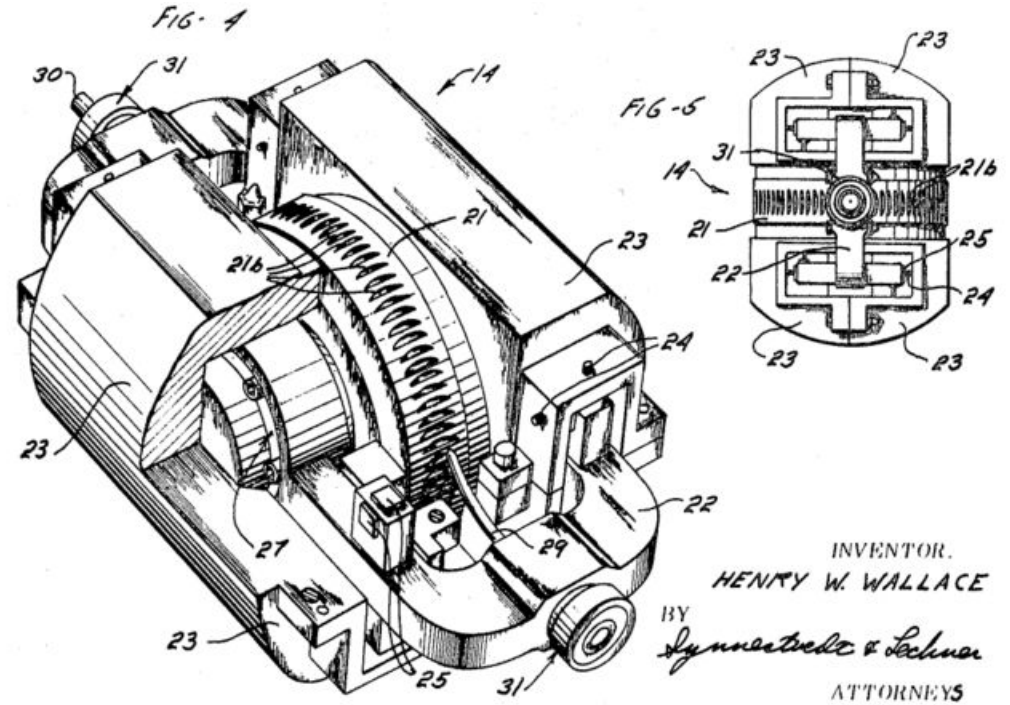

# Laithwaite Gyroscopes (1974)

- Eric Laithwaite - invented “Maglev”
- Hypothesis: Rotating spinning disc creates a force orthogonal to both spin and direction
- Claims that mechanical kinetic forces can cause weight change
- Newton’s 2nd Law explains this effect:

$$\underline{Q}(e) = \underline{\dot{h}}_p + \underline{\dot{r}}_p \times \underline{p}$$

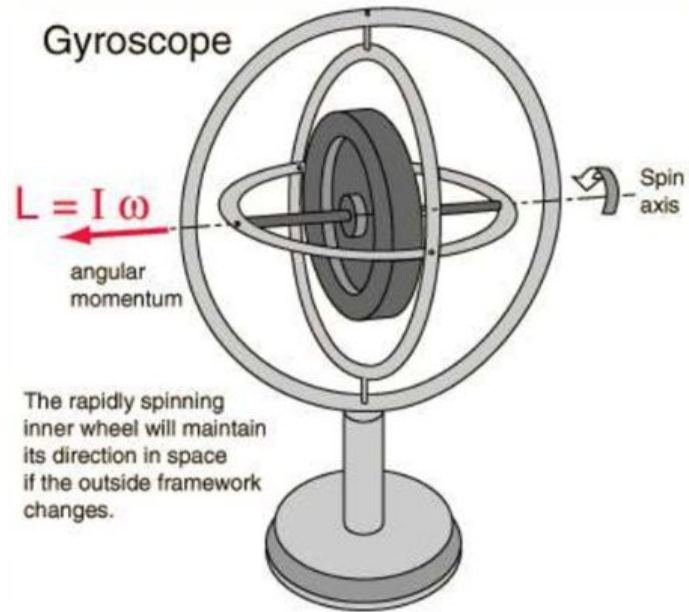

# Antigravity Research - Modern Efforts



# Mansfield Amendment (1973)

- Restricted research by the DoD for non-military applications
- Included antigravity research
- This means most modern antigravity research has been outsourced to the private sector (and/or black budgets)



# Hutchison Effect (1970's)

- “Anomalous effects” noted while attempted to recreate Tesla experiments
- Claims of Philadelphia Experiment reproductions
- Loss of ability



# Woodward Effect/ Mach Effect (1990)

- Proposed by Jim Woodward as a “reactionless thruster”
- Theorized to enable a “Warp Drive” via a large negative mass warping space time
- Large negative mass in a small point theorized to create stable traversable wormholes (alcubierre drive)

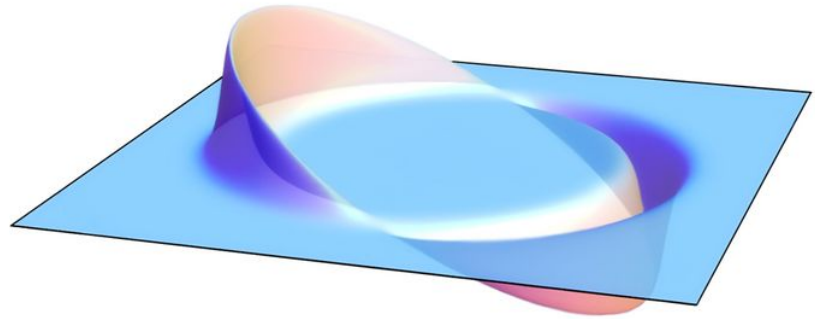

# Ning Li & Doug Torr AC Gravity (1990's)

- UAH scientist who theorized a magnetic field applied to a superconductor will align ion spins to produce gravitomagnetic & gravitoelectric effect.
- 1999 Popular Mechanics article
- UAH and NASA MSFC collaboration ~1996
- Left UAH and founded AC Gravity LLC, 1999
- \$500,000 DoD contract in 2001



# What happened to Ning Li?

 r/conspiracy

Posts



Join the discussion

BECOME A REDDITOR



Posted by u/[deleted] 6 years ago

25



**What happened to Dr. Ning-Li? (invented superconductor-based anti-gravity, joined DARPA, disappeared?)**

**tldr** she goes from Physics professor and researcher at Alabama, then starts her own company to develop her technological breakthrough, then she signs a contract with DARPA, then no trace after that

her [short wiki](#) provides a brief introduction

and the first post in [this thread](#) follows her known activity from 1998 until the trail runs cold...

anyone here have any idea what may have happened? or what the latest is on this technology?

 10 Comments  Share  Save ...

87% Upvoted

# Podkletnov Effect (1990's - 2000's)

- Rotating (YBCO) superconductor produces “gravity shielding”
- 2001 patent
- Collaboration with NASA MSFC in early 2000's
- Claimed 2% reduction in weight
- Widely panned by community
- However, some near-replications have been done (Poher)

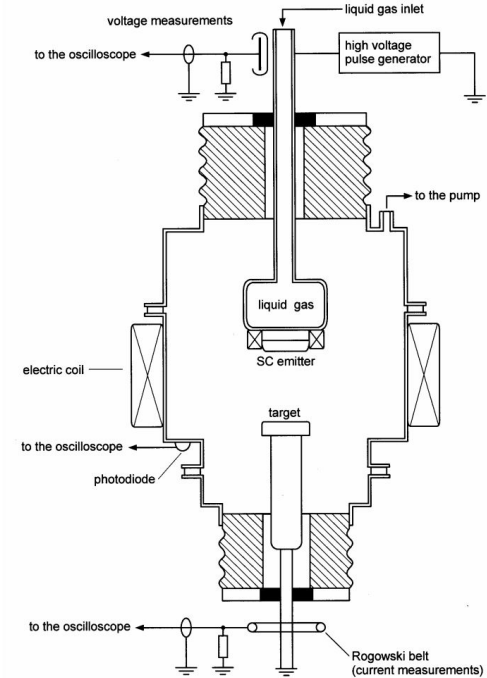
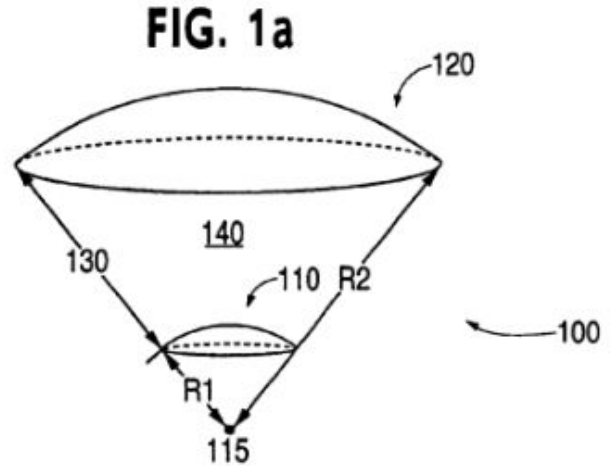

Fig. 1

# Torr, Jose Vargas, Timir Datta (2001)

- “Gravity beam generator” work at University of South Carolina
- Creation of an “inhomogenous electric field” with two asymmetric hollow concentric electrodes
- Experimental Quantum Gravity website still online
- Torr’s present work unclear



# Li, Torr, Podkletnov & Modanese Panning

- Ning Li - Popular Mechanics article no longer available
- Doug Torr - University of South Carolina research never made public
- Podkletnov - ousted by University of Tampere (1997)
- Giovanni Modanese - Wikipedia page deleted

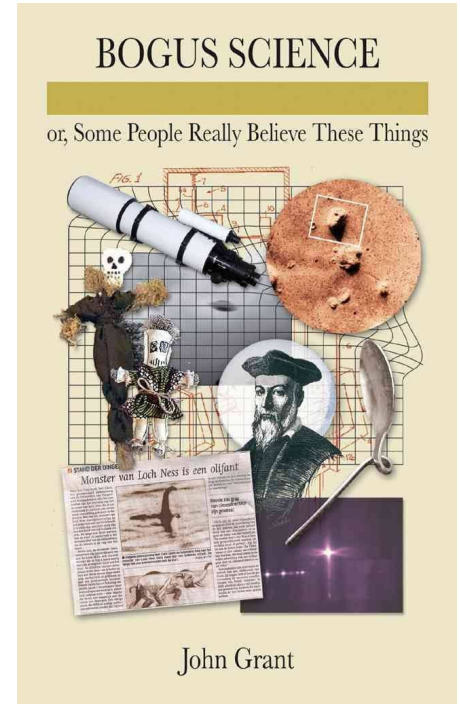

# Claude Poher (2000's-Present)

- Modification of Podkletnov Effect
- Propelling force claimed to result from discharge of YBCO disc
- “Universons” theory
- Tested at NASA MSFC, 2015

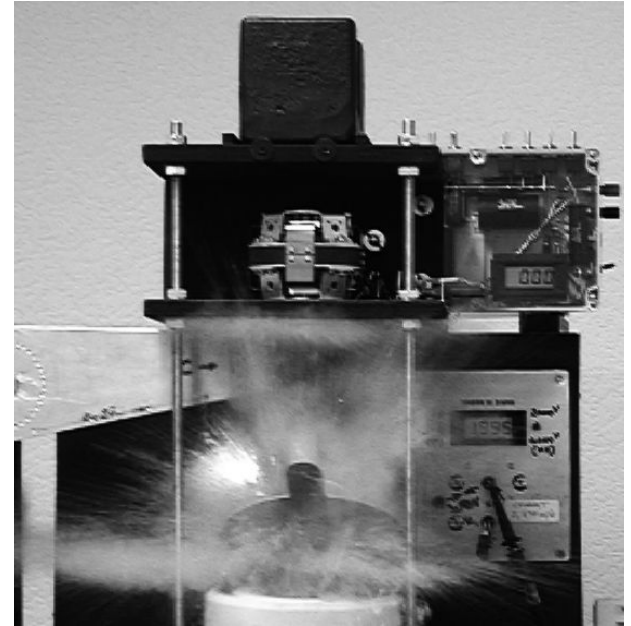
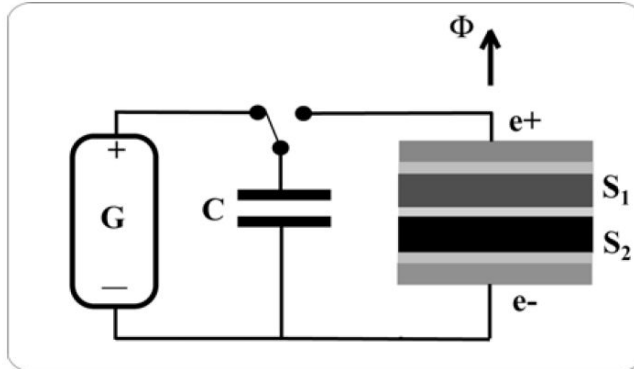

# Morningstar Applied Physics (2000's-present)

- Paul Murad and John Brandenburg
- Modified Searl Machine with Gravito-Electric-Magnetism (GEM) Theory
- Claimed 7% weight reduction

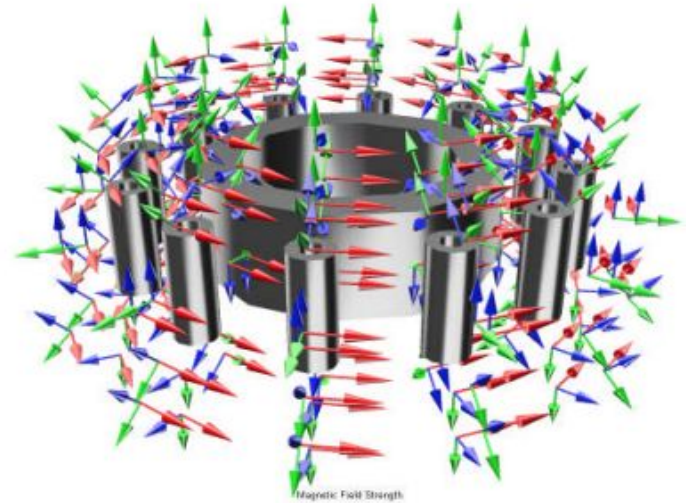
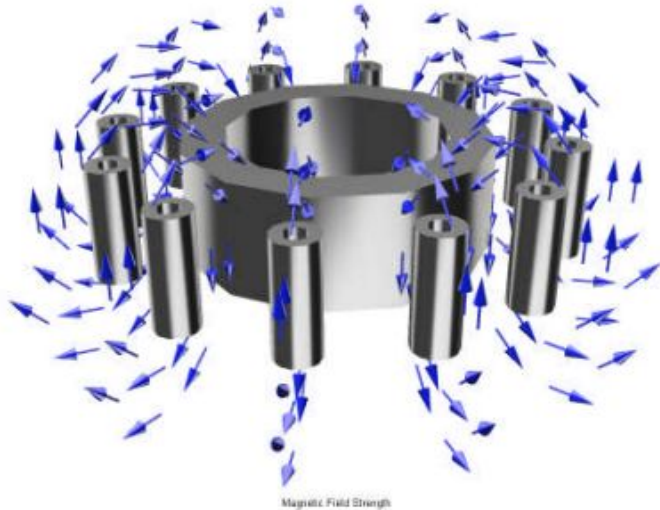

# Boeing Phantomworks (2010's)

- Gravity Research for Advanced Propulsion (GRASP) program admitted to in 2014
- Podkletnov is a collaborator?
- TR3B “Black Triangle” “Alien Reproduction Vehicle” is the result?
- Mechanism resembles Brown Generator?

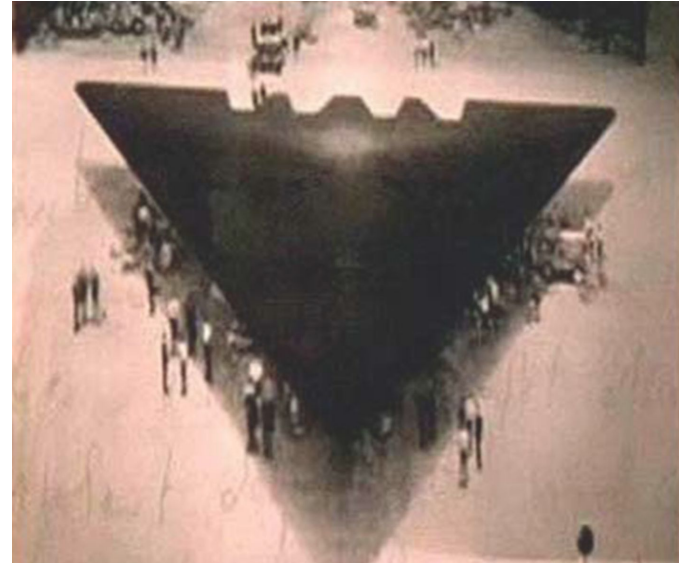

# Recent Declassifications

Declassification of  
AATIP documents  
(Advanced  
Aviation Threat  
Identification  
Program) in Dec  
2017

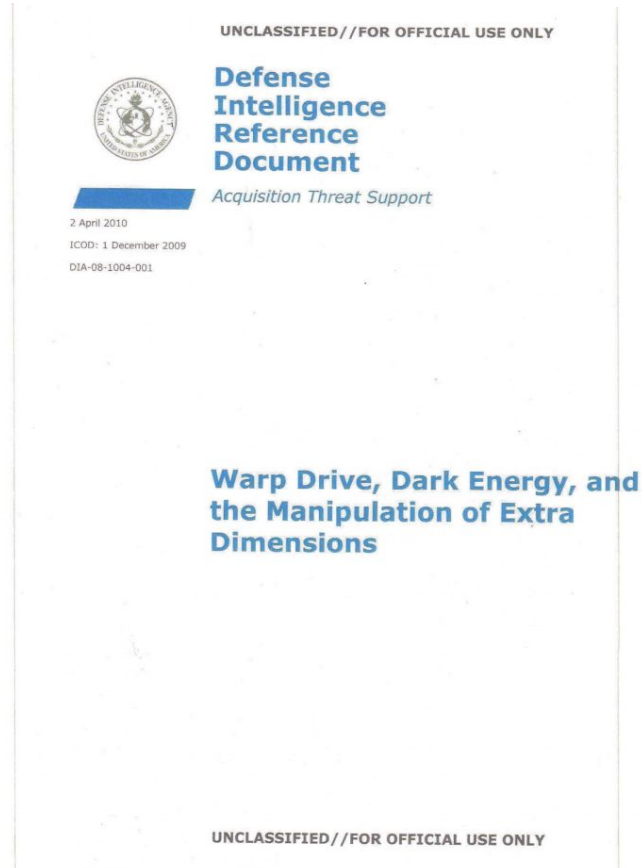
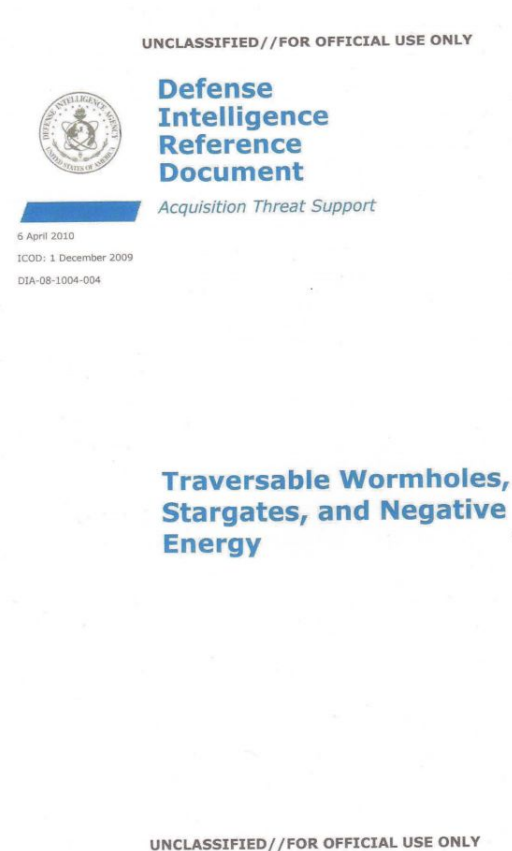

# THE FUTURE

What's the next step?



# Conclusion

## What Now?

- We need theories with a testable hypothesis
- Independently funded research by private interests is required
- Promising results always disappear into the classified realm-how do we fix this?

THANK  
YOU



@ExoticInstitute @amyceskridge



amy@instituteforexoticscience.com

INSTITUTEFOREXOTICSOURCE.COM

THE  
INSTITUTE

EXOTIC SCIENCE. EXOTIC RESULTS.

# CASE #979

[Direct PDF Download](#)

## SOURCE URL

<https://www.hal5.org/PDF/HAL5-Dec2018-Talk-AntiGravity.pdf>

## DOMAIN

[www.hal5.org](http://www.hal5.org)

## CASE ID

#979 of 924

## CONTEXT FROM ORIGINAL DOCUMENT

\_Xu24Jog

-